

SENITEC

Position Indicating Devices

NEMA 3/4/4X/7/9

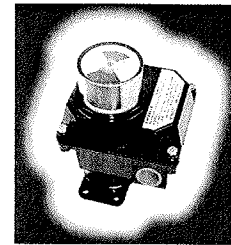

INSTALLATION & SETUP MANUAL

WARNING!

- **THE INFORMATION CONTAINED IN THIS MANUAL IS INTENDED FOR QUALIFIED INSTALLATION PERSONNEL ONLY. USE OF THIS INFORMATION BY ANYONE ELSE COULD RESULT IN SERIOUS INJURY.**
- **TO PREVENT FIRE OR EXPLOSION WITH TYPE 4, 4X, 7 and 9 ENCLOSURES, INSTALL SEAL FITTINGS WITHIN 18 INCHES OF THE ENCLOSURE.**
- **USING THIS DEVICE IN A MANNER NOT SPECIFIED BY SENITEC MAY IMPAIR ITS INHERENTLY DESIGNED PROTECTION.**

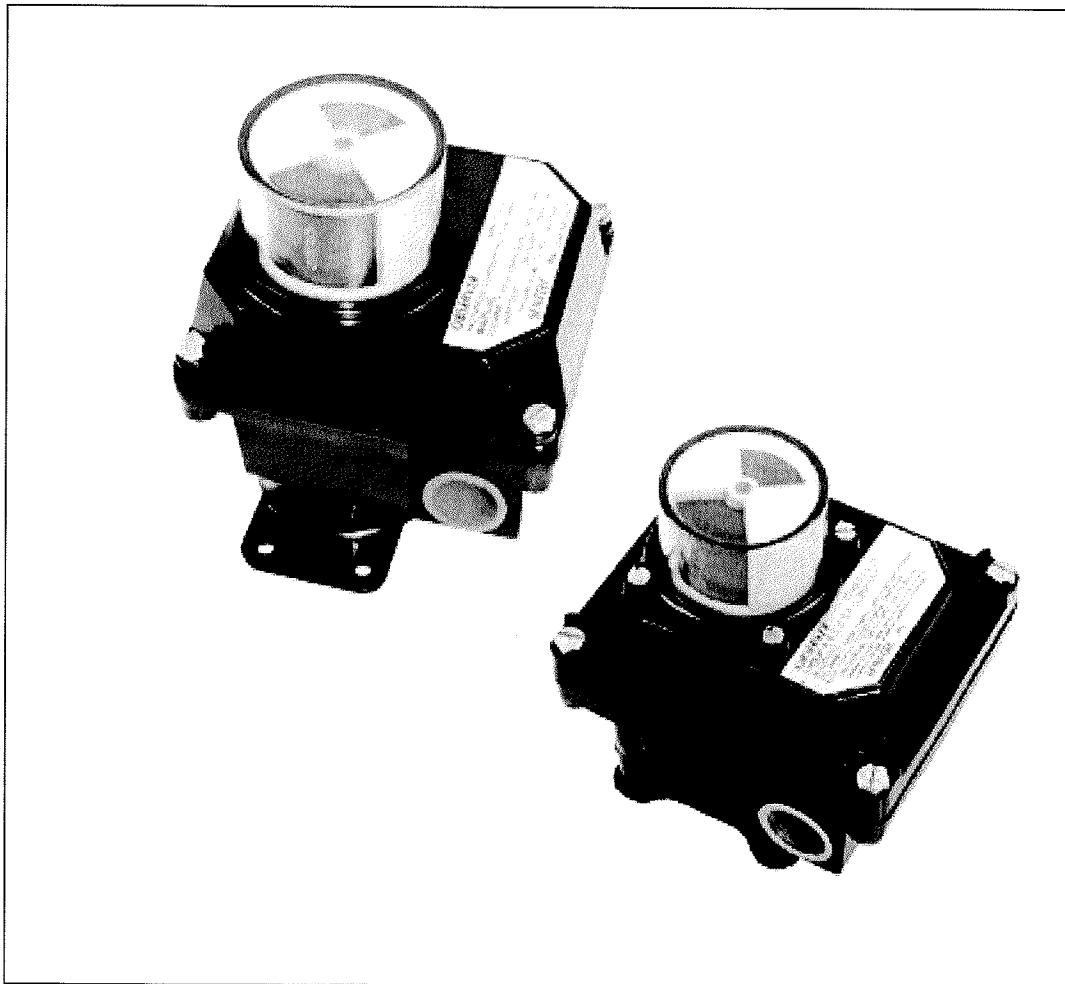

Setting Position Indicating Devices (PIDs) to Actuators

WARNING!

TO PREVENT POSSIBLE PERSONAL INJURY OR PROPERTY DAMAGE, TURN OFF ELECTRICAL POWER BEFORE INSPECTING, ADJUSTING OR REMOVING THE PID HOUSING COVER.

Caution!

To reduce the risk of igniting hazardous atmospheres, disconnect the PID from the supply circuit before opening. Keep assembly tightly closed during operation.

1. Attach the Position Indicating Device (PID) to the valve with the appropriate mounting hardware.

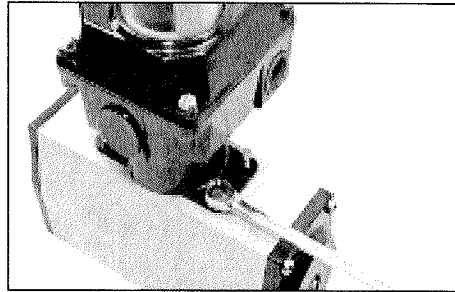

2. Remove the PID top housing cover by completely loosening its four corner captive screws.

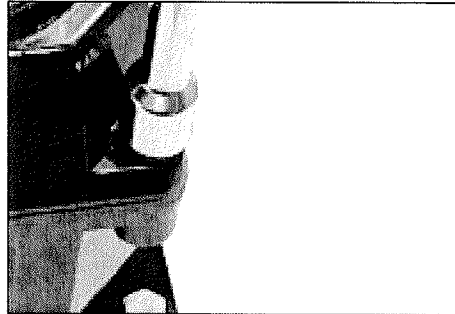

3. After determining the actual operating rotating direction of the shaft assembly for your valve/actuator, set the Switch 1 cam (the lowest switch) to the desired position where it will trigger. To adjust, firmly grasp the cam with your fingers and rotate clockwise or counter-clockwise until it "clicks" into the desired position.

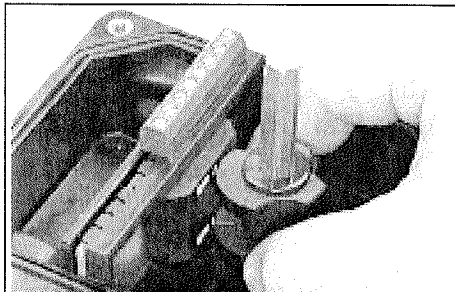

4. Verify the switch triggering point by placing ohmmeter (or other continuity-type tester) test leads across the proper Switch 1 wiring terminals. Refer to the wiring diagrams provided on page 6 of this manual, or to those inside the housing top cover.



5. Repeat steps 3 and 4 for all of the remaining switches.
6. Connect peripheral devices to the wiring block using the same diagrams discussed previously in step 4, as well as the device manufacturer's wiring instructions.

Adjusting the Visual Indicator (Co-Polyester Housings)

1. With the housing cover in place, determine the “true” valve position (Open or Closed) and compare it to the PID visual indication.
2. If adjustments are necessary, remove the housing cover (for metal housings see special procedure below) and from the underside, lightly depress the indicator’s internal tabs and rotate clockwise or counter-clockwise to the appropriate setting.
3. Return the housing cover and check the setting once again. If necessary, repeat step 2 as many times as required to attain the correct setting.
4. With the housing cover properly seated to its original mounting position, tighten the four captive screws.

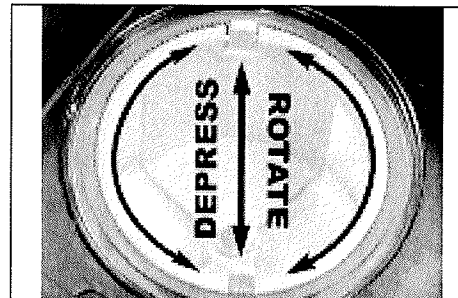
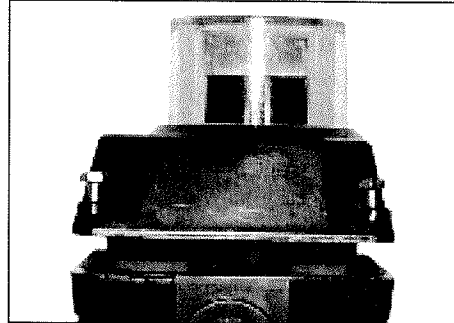

For Metal Housing PIDs...

1. Verify that the housing cover is removed as described previously (step 2, page 2).
2. Completely loosen the four captive screws on the clear indicator cover.
3. Remove the clear cover and then the indicator itself.
4. Reattach the housing cover, align it with the base and firmly slide the cover over the shaft.
5. Place the indicator back on the shaft making sure it aligns properly with the notch located toward the top of the shaft as shown.
6. Make the same tab adjustments as described above in step 2 for co-polyester housings.
7. Return the clear cover to its original location over the indicator.
8. Tighten the four captive screws on the clear indicator cover, and on the housing cover.

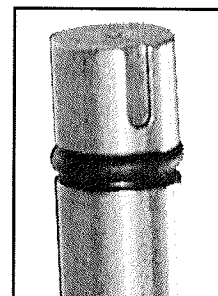
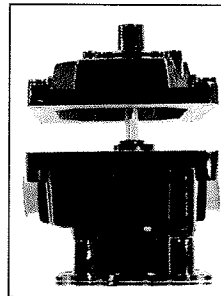
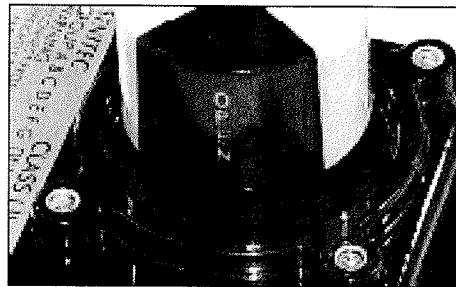

Switch Type Electrical Specifications

CODE	SWITCH TYPE	CONTACTS	RATING
A	Mechanical - Silver	SPDT, Form C	10A - 250V
B	Mechanical - Gold	SPDT, Form C	0.1A - 125V
E	Mechanical - Silver	DPDT	2A - 120VAC; 75VDC
C	Proximity - Tungsten	SPDT, Form C	3A - 120V
D	Proximity - Rhodium	SPDT, Form C	1A - 150V
F	Inductive		
G	AS-I		
I	Intrinsically Safe		

Switch Wiring Diagrams

Switch Types A, B, C, and D

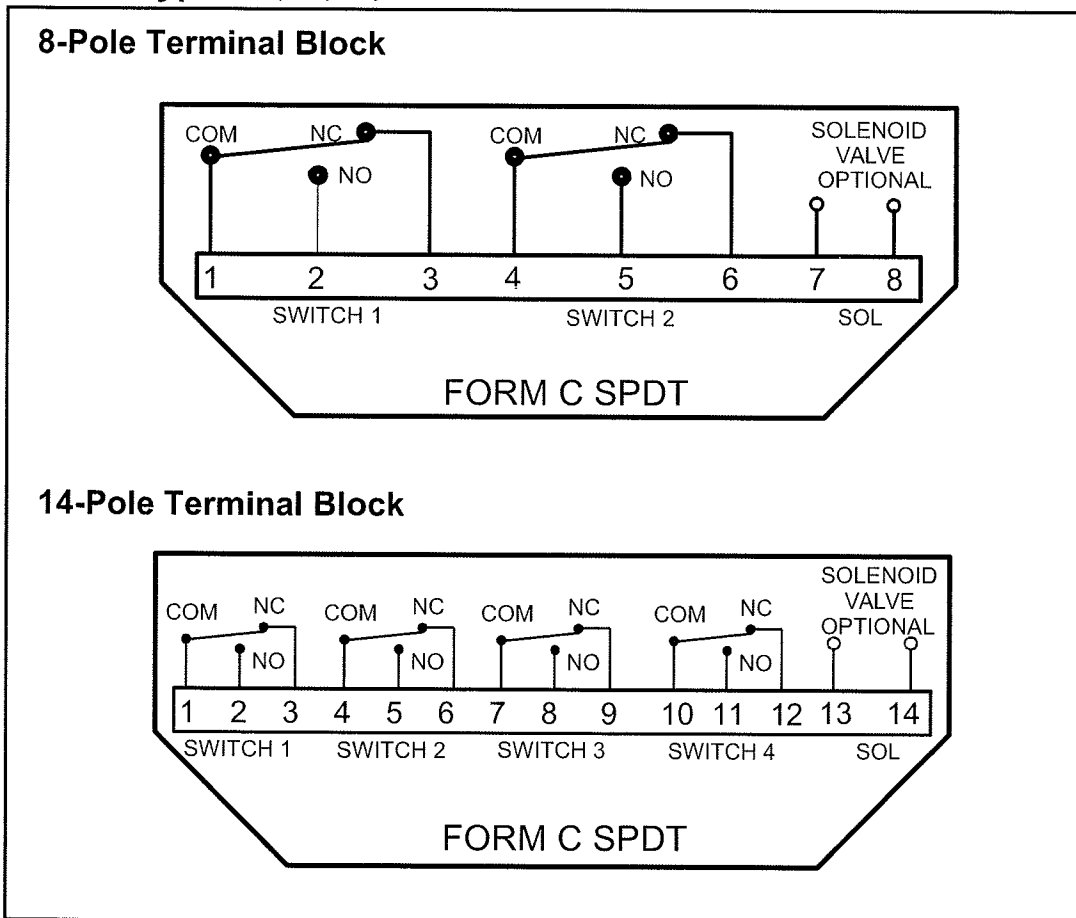

Switch Type E

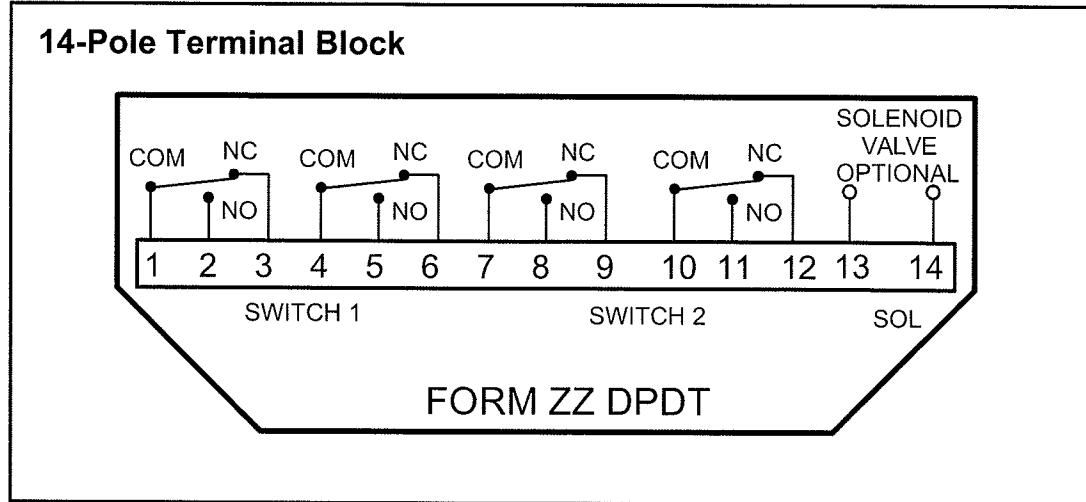

SENITEC, Inc.

2825 Pacific Drive Norcross, GA. 30071
Tel: (770) 416-1202 Fax: (770) 446-1620
sales@senitc.com www.senitec.com

Copyright © 2003
All Rights Reserved